

LaViuda

MONOBLOCK

CAJÓN DE PVC

PVC SHUTTER BOX

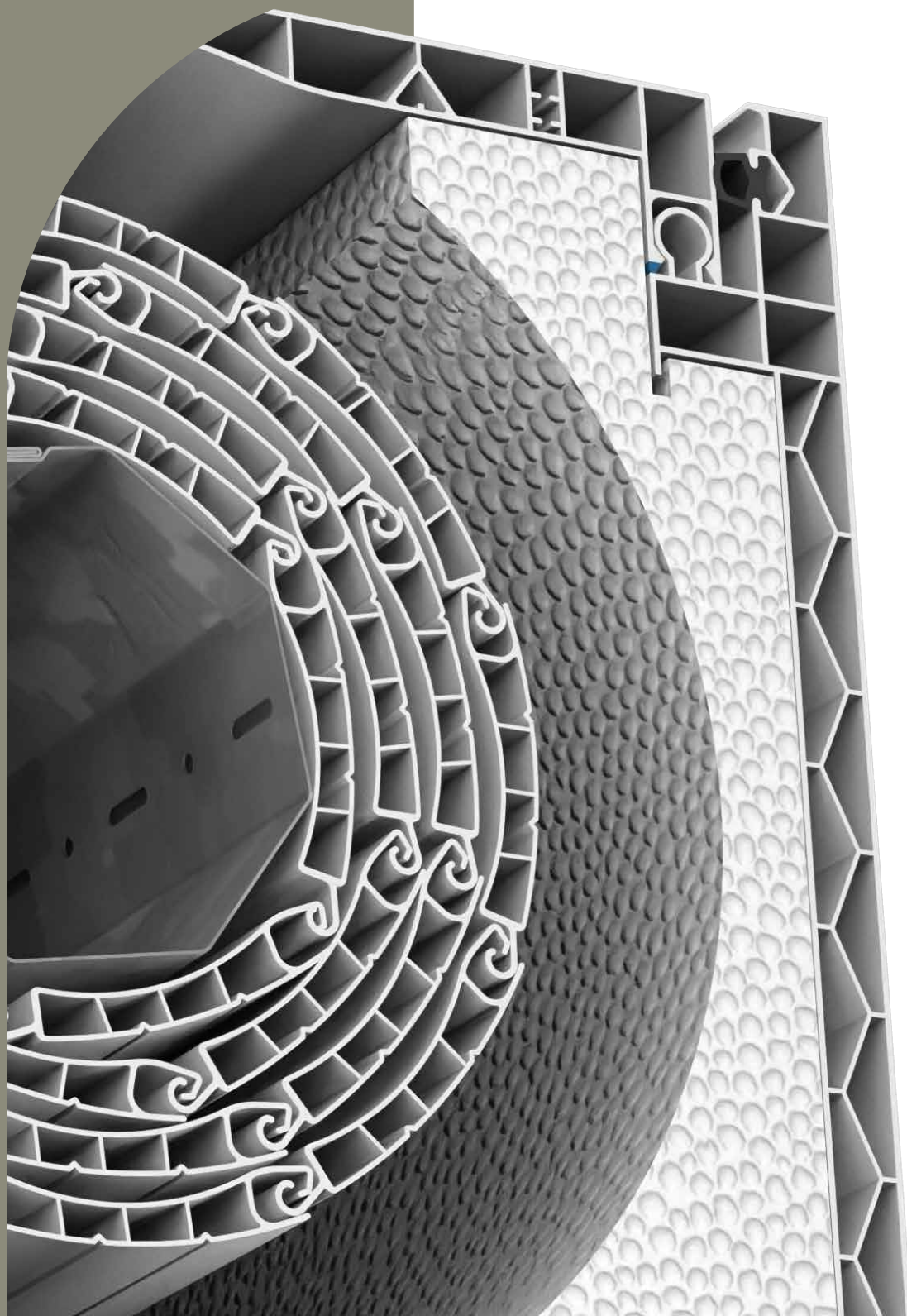

#13

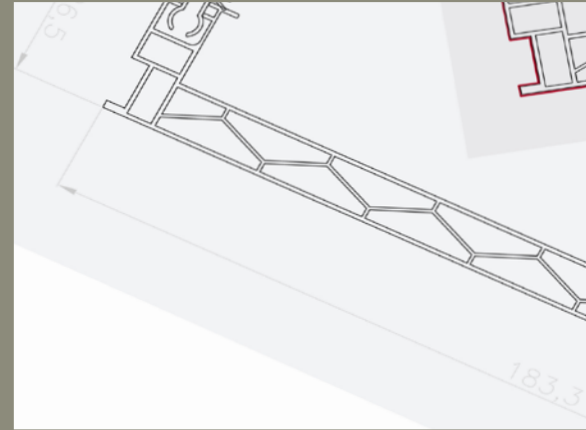

LaViuda nace en Sax, pequeña localidad de la provincia de Alicante. En la actualidad nuestros productos están presentes en 4 continentes.

Diseñamos y fabricamos nuestra propia matricería, somos formuladores y fabricantes de granza de PVC y garantizamos el suministro y la precisión de nuestra variada oferta de cajón monoblock que se caracteriza por el sello distintivo de calidad y durabilidad de los productos LaViuda.

La paleta cromática compuesta por más de 100 tonalidades de la carta RAL, coloreadas en masa por extrusión, los cinco tamaños diferentes con posibilidad de combinatoria de PVC y aluminio, y los más de 50 certificados de ensayos que cumplen la normativa actual para la construcción, hacen de nuestra gama de cajón monoblock para persiana la oferta más amplia del mercado.

El cajón monoblock forma un bloque compacto que se adapta a cualquier tipo de carpintería. Se convierte en una solución práctica para nuevas construcciones, ya que junto con la ventana, proporciona aislamiento térmico y acústico, confort, privacidad y protección a la vivienda.

LaViuda is based in Sax, a small town in the province of Alicante (Spain). Currently, our products are present in 4 different continents.

We design and manufacture our own PVC moulds, we develop and manufacture our own PVC pellets, so we guarantee the supply and precision of our varied offer of monoblock shutter box systems that is characterized by the distinctive seal of quality and durability of LaViuda products.

With more than 100 RAL chart colours, mass coloured by extrusion, the five different sizes with the possibility of combining PVC and aluminium in several designs and the more than 50 test certificates which comply with current construction regulations, make our range of monoblock shutter boxes the largest available in the market.

The monoblock shutter box forms a compact block that adapts to any type of window carpentry. It becomes a practical solution for new constructions as it provides, together with the window, thermal and acoustic insulation, comfort, privacy and protection to the house.



ÍNDICE / INDEX

CAJÓN DE PVC REGILUX	/ 08 /
<i>PVC Shutter Box Regilux</i>	
CAJÓN DE PVC MOSQUITERA INTEGRADA	/ 09 /
<i>PVC Shutter Box with built-in mosquito net</i>	
CAJÓN DE PVC REGILINE	/ 10 - 11 /
<i>PVC Shutter Box Regiline</i>	
CAJÓN DE PVC REGIBLOCK	/ 12 - 13 /
<i>PVC Shutter Box Regiblock</i>	
CAJÓN DE PVC MODULBLOCK	/ 14 /
<i>PVC Shutter Box Modulblock</i>	
PERFIL INFERIOR REGISTRABLE	/ 15 /
PARA CAJÓN TÚNEL	
<i>Lower accesible profile for Tunnel-type box</i>	



**PROTECCIÓN
SOLAR**
Solar Protection



**EFICIENCIA
ENERGÉTICA**
Energy Efficiency



**ELEVADA
ATENUACIÓN
ACÚSTICA**
High Acoustic Attenuation



VENTILACIÓN
Ventilation



PRIVACIDAD
Privacy



**RESISTENCIA
AL VIENTO**
Wind Resistance



**PROTECCIÓN
FRENTE A
INSECTOS**
*Effective protection
from insects*



**GRANDES
DIMENSIONES**
Large Dimensions



**INTEGRACIÓN
TOTAL**
Total Integration



**ADAPTABLE
A CUALQUIER
CARPINTERÍA**
Adaptable to any carpentry



REGISTRABLE
Accesible



**FÁCIL
INSTALACIÓN**
Easy Installation

ADAPTA EL CAJÓN MONOBLOCK A TU SOLUCIÓN CONSTRUCTIVA

ADAPT THE MONOBLOCK SHUTTER BOX TO YOUR BUILDING NEEDS

**AMPLIA GAMA DE COLORES
Y ACABADOS, compatible con todos
los sistemas de maniobra**

*WIDE RANGE OF COLORS AND FINISHES, compatible with all
maneuvering systems*

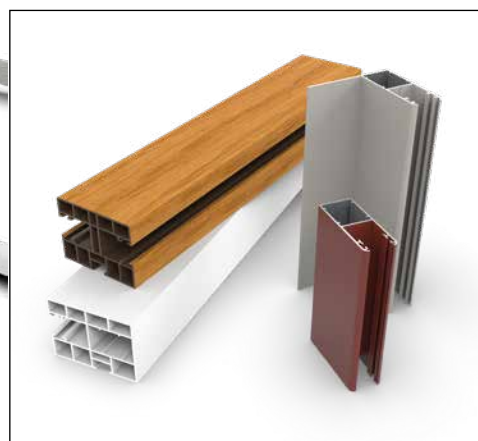
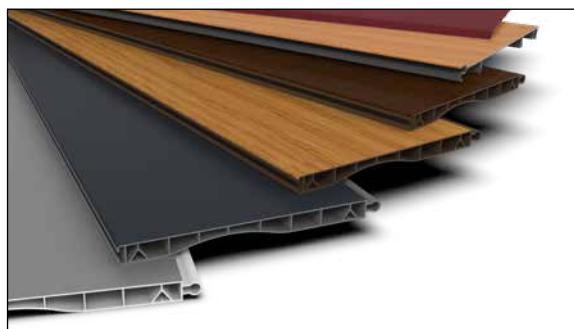

**Diferentes opciones para una versatilidad
de INSTALACIÓN TOTAL**

Different options for a versatile INSTALLATION

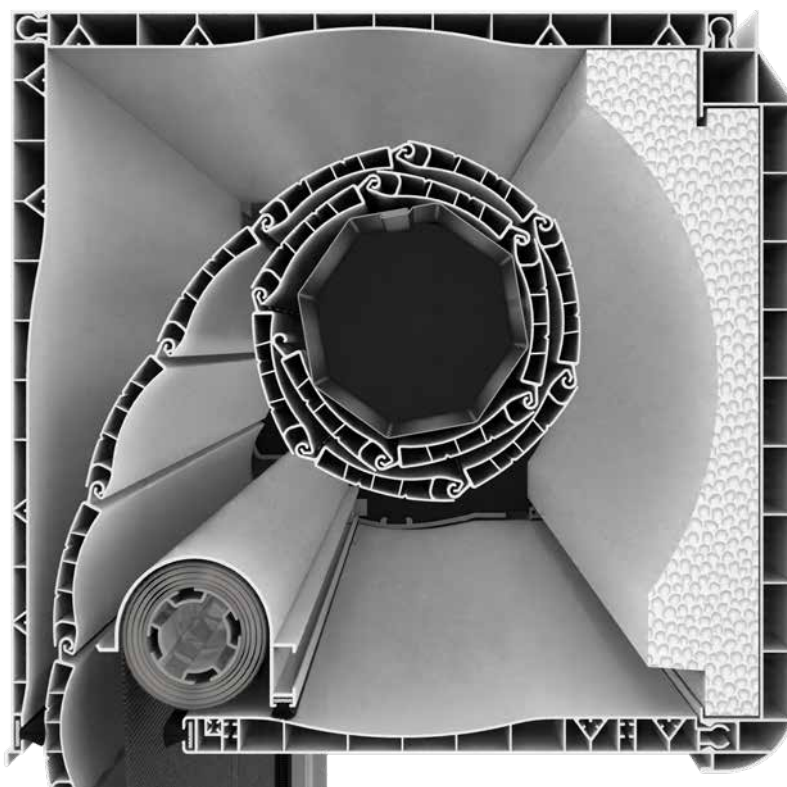

**Mosquitera
enrollable integrada
PATENTADA**

*PATENTED integrated roller system
mosquito net*

Sistema de motorización rápido FASTOR PATENTADO
PATENTED fast motorisation system FASTOR

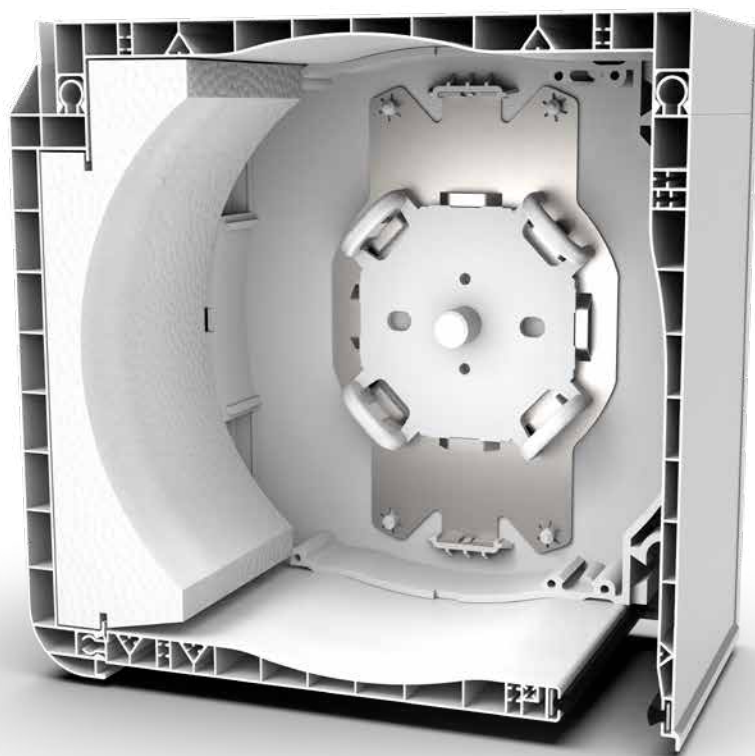

**Combina los perfiles SEGÚN TUS NECESIDADES /
Diferentes aislantes PARA CADA PRESTACIÓN / SISTEMA
FUTURBOX (Combinación PVC + Aluminio)**

*Combine different profiles ACCORDING TO YOUR NEEDS / Different insulating systems available
FOR EACH PERFORMANCE / FUTURBOX SYSTEM (Combination of PVC+Aluminum)*

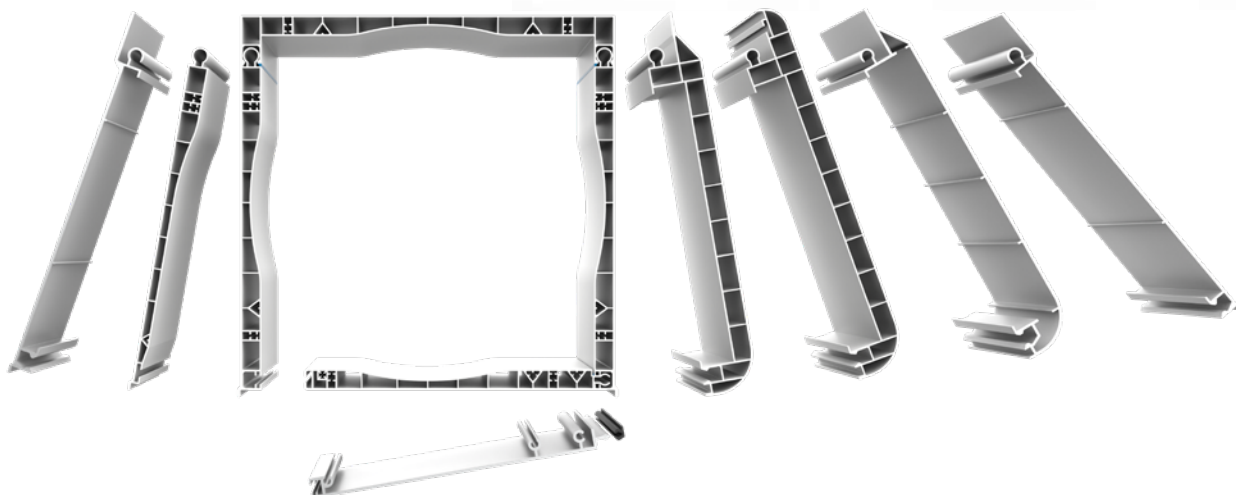
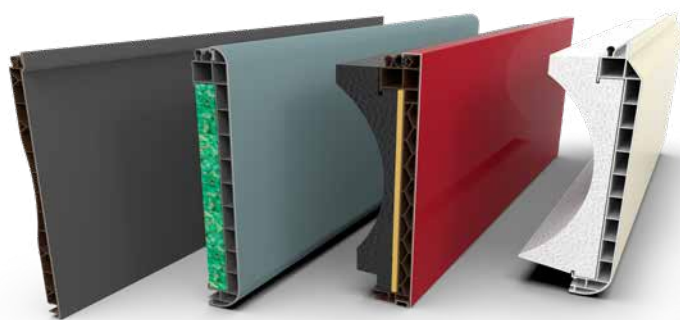
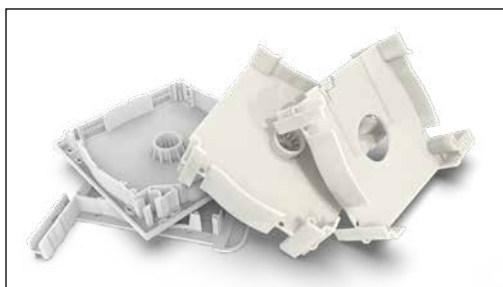

REGILUX

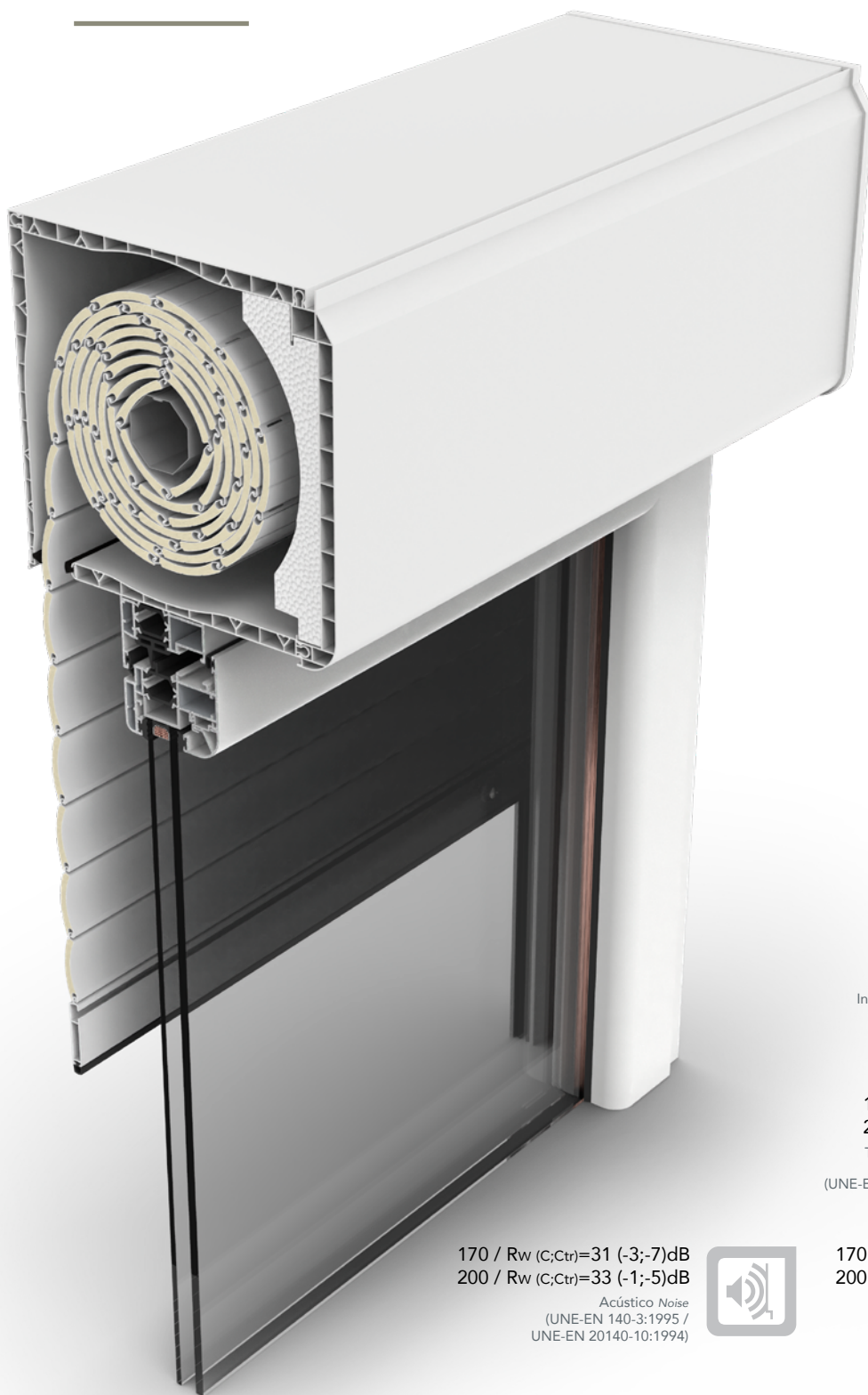

M1
(UNE 23727-90 1R)
Informe de clasificación
Classification report
Nº 7000 AITEX



170 / 1,4 W/m²K
200 / 1,0 W/m²K
Transmisión térmica U
Thermal transmission
(UNE-EN ISO 10077-2:2008)



170 / Rw (C;Ctr)=31 (-3;-7)dB
200 / Rw (C;Ctr)=33 (-1;-5)dB
Acústico Noise
(UNE-EN 140-3:1995 /
UNE-EN 20140-10:1994)



170 / CLASE class 4
200 / CLASE class 3
Permeabilidad al aire
Air permeability
(UNE-EN 1026:2000)



170 / CLASE class 9A
200 / CLASE class 7A
Estanqueidad al agua
Water resistance
(UNE-EN 1026:2000)



P3: 3000 Pa
Resistencia al viento
Wind load resistance
(UNE-EN 12211:2000)



170-200

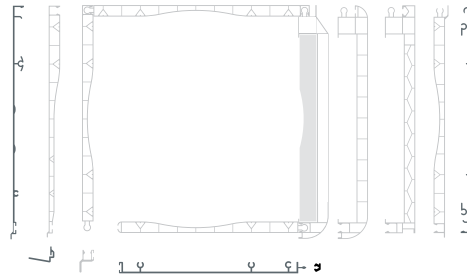

REGILUX

CON MOSQUITERA INTEGRADA

PVC BOX WITH
INTEGRATED ROLLER
SYSTEM MOSQUITO NET

200

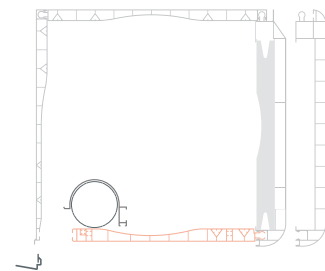

V / CAJÓN DE PVC MONOBLOCK
PVC SHUTTER BOX

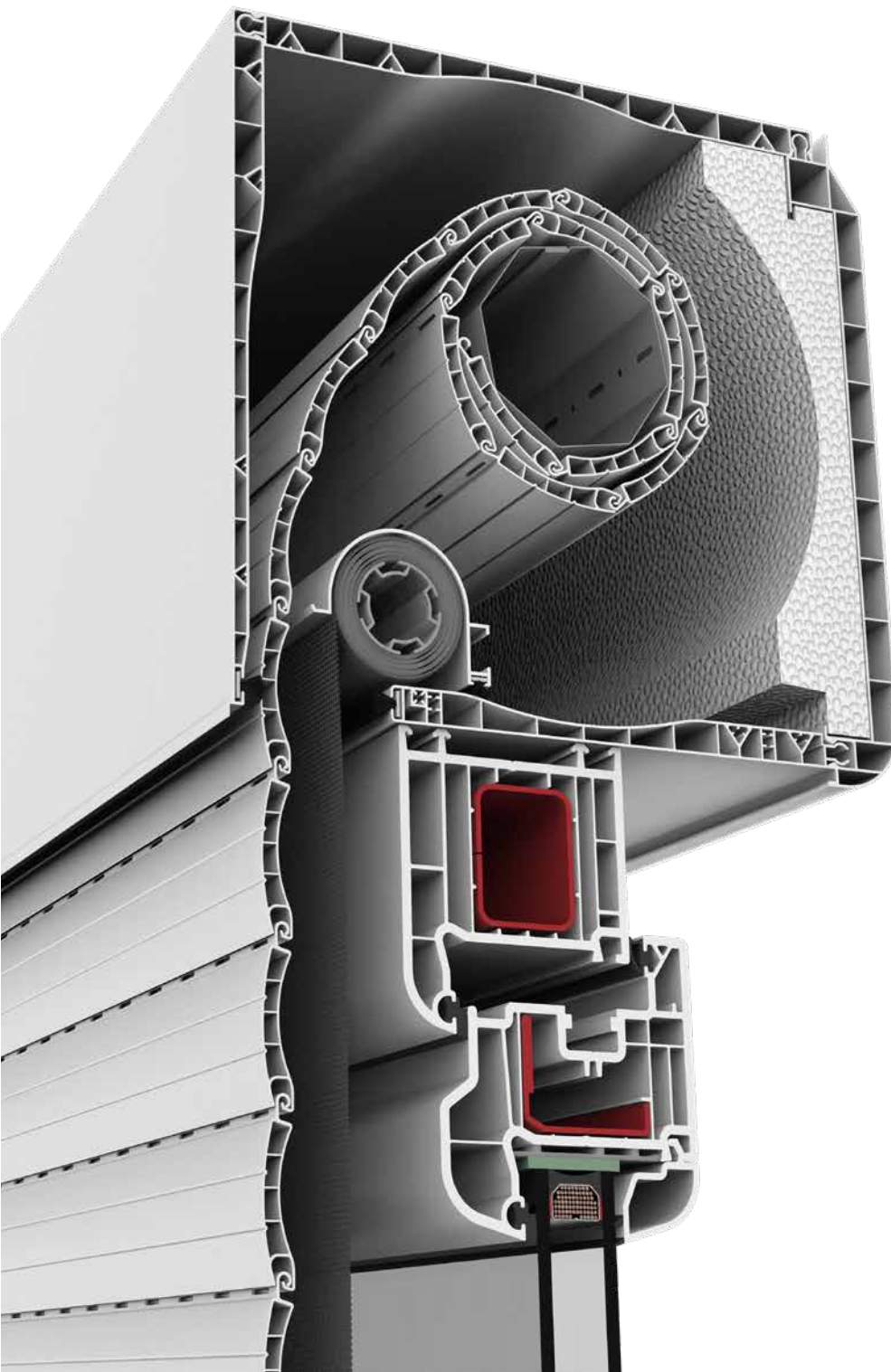

REGILINE

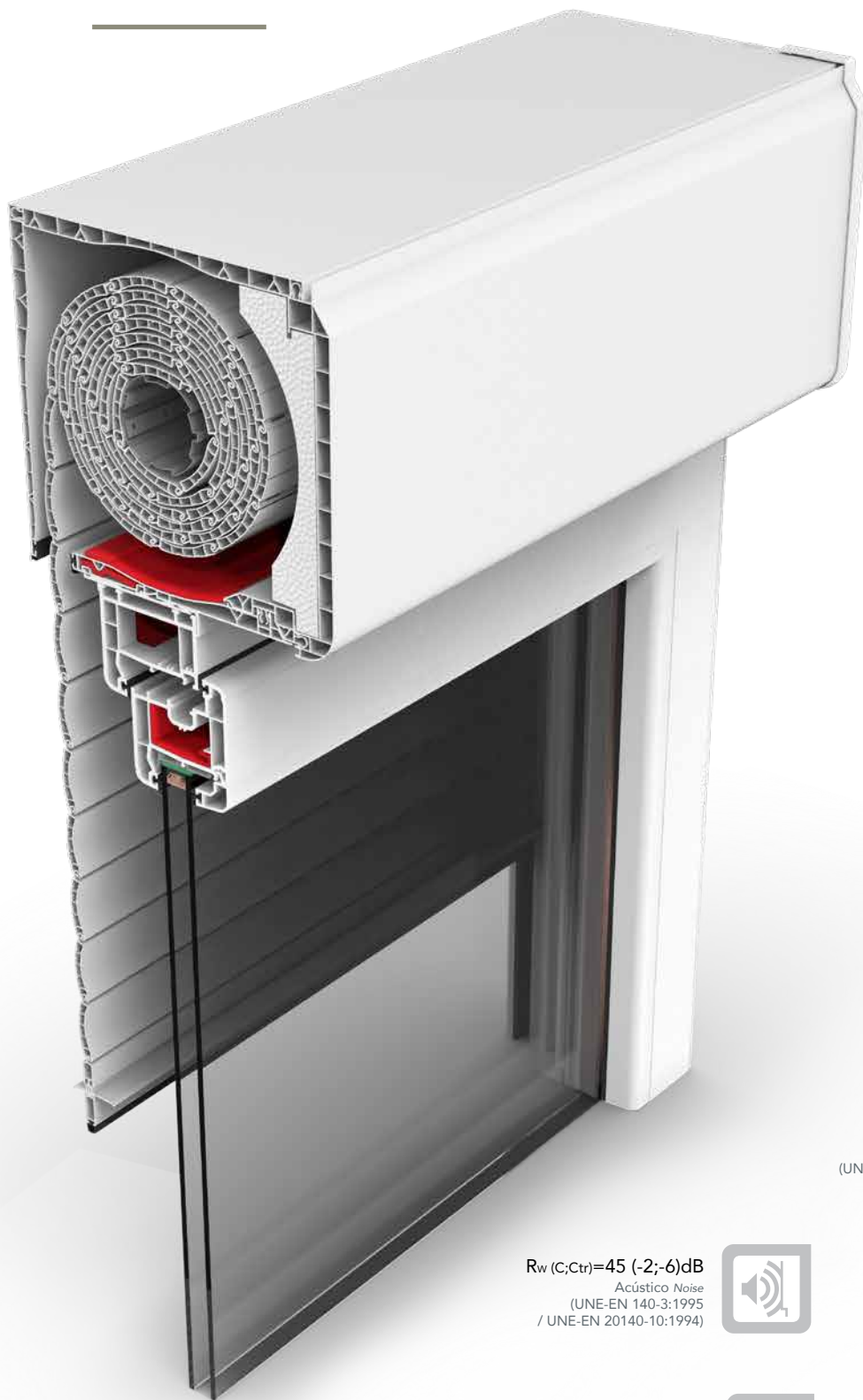

1,0 W/m²K
Transmisión térmica U
Thermal transmission
(UNE-EN ISO 10077-2:2008)



R_w (C;Ctr)=45 (-2;-6)dB
Acústico Noise
(UNE-EN 140-3:1995
/ UNE-EN 20140-10:1994)



CLASE class 4
Permeabilidad al aire
Air permeability
(UNE-EN 1026:2000)



CLASE class E3000
Estanqueidad al agua
Water resistance
(UNE-EN 1026:2000)



P3: 3000 Pa
Resistencia al viento
Wind load resistance
(UNE-EN 12211:2000)



200

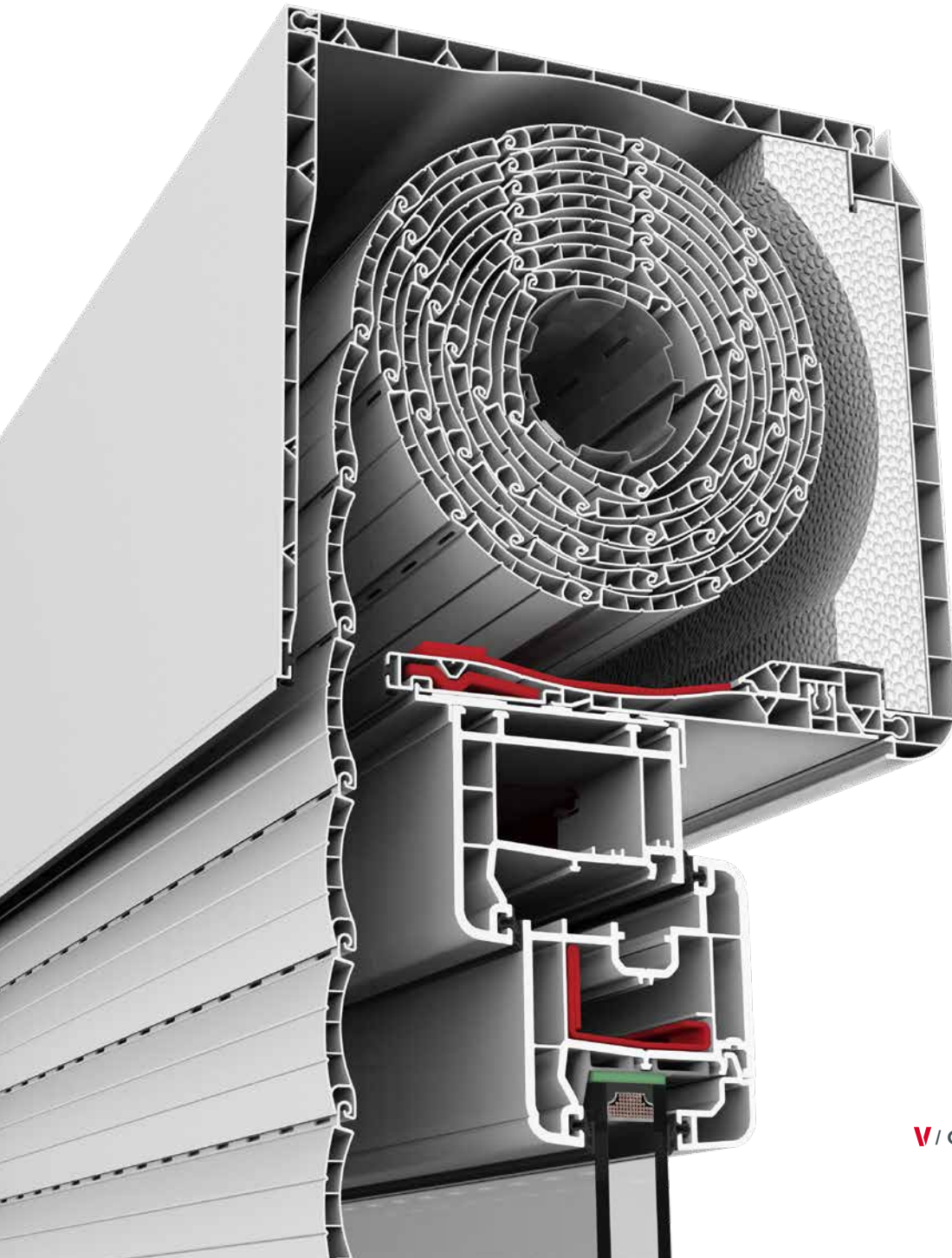
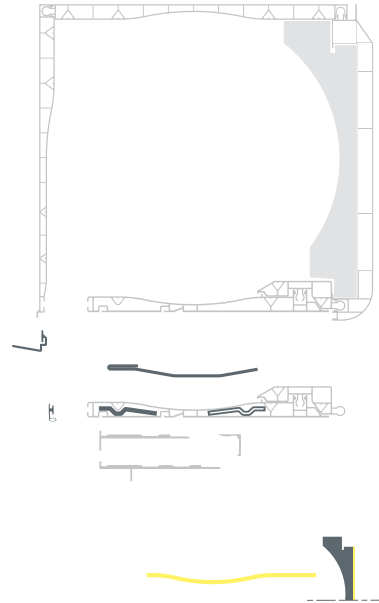

REGIBLOCK

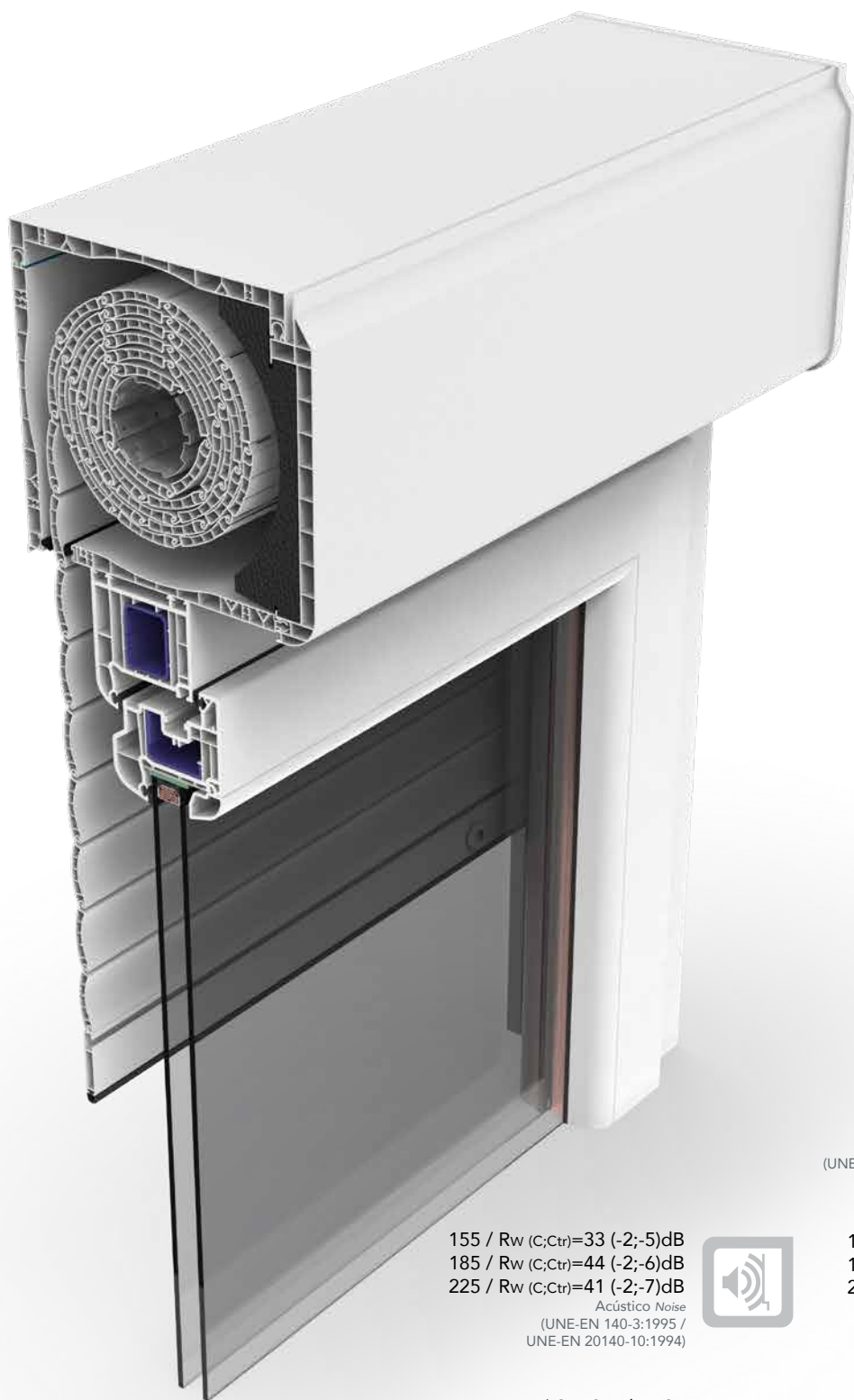

M1
(UNE 23727-90 1R)
Informe de clasificación
Classification report
N° 7000 AITEX



155/ 0,85 W/m²K
185/ 0,80 W/m²K
225/ 1,10 W/m²K
Transmisión térmica U
Thermal transmission
(UNE-EN ISO 10077-2:2008)



155 / Rw (C;Ctr)=33 (-2;-5)dB
185 / Rw (C;Ctr)=44 (-2;-6)dB
225 / Rw (C;Ctr)=41 (-2;-7)dB
Acústico Noise
(UNE-EN 140-3:1995 /
UNE-EN 20140-10:1994)



155 CLASE class 4
185 CLASE class 4
225 CLASE class 3
Permeabilidad al aire
Air permeability
(UNE-EN 1026:2000)



155 / CLASE class 9A
185 / CLASE class E1200
225 / CLASE class E3000
Estanqueidad al agua
Water resistance
(UNE-EN 1026:2000)



P3: 3000 Pa
Resistencia al viento
Wind load resistance
(UNE-EN 12211:2000)



170-200

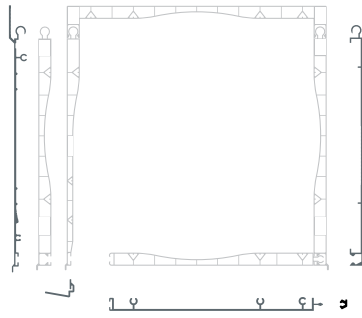
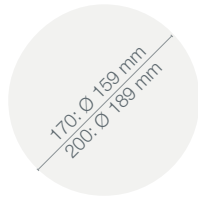

155-185

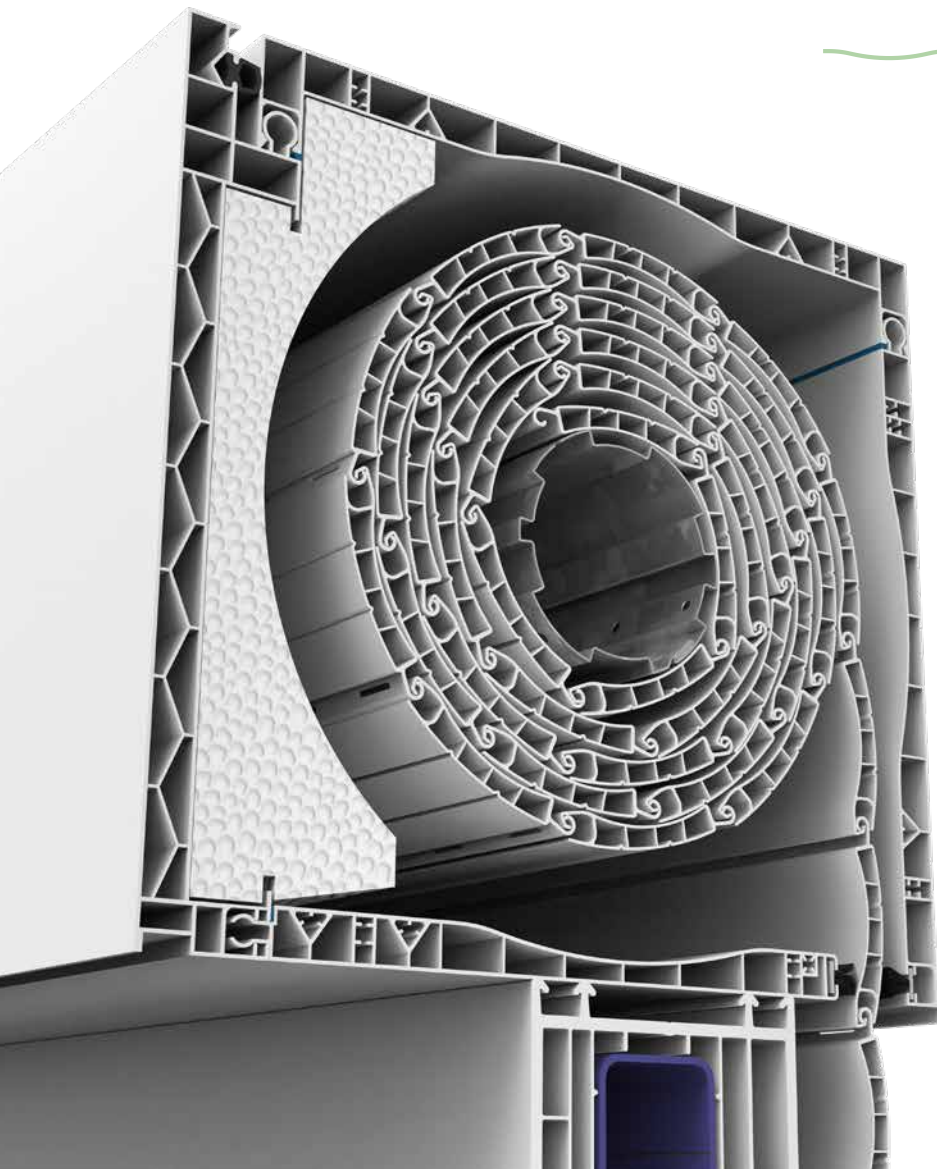
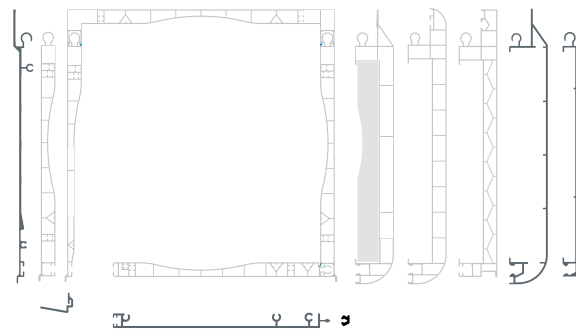

225

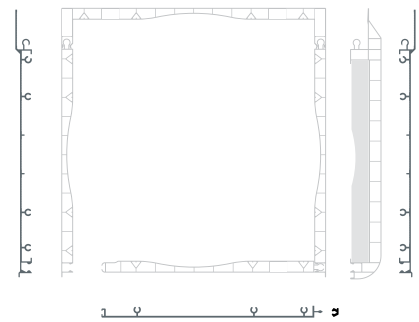
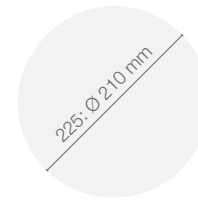

MODULBLOCK

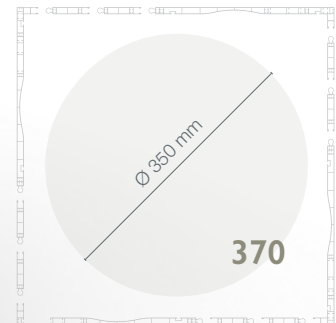
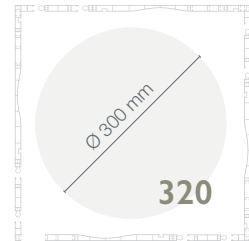
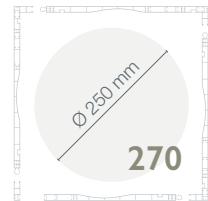
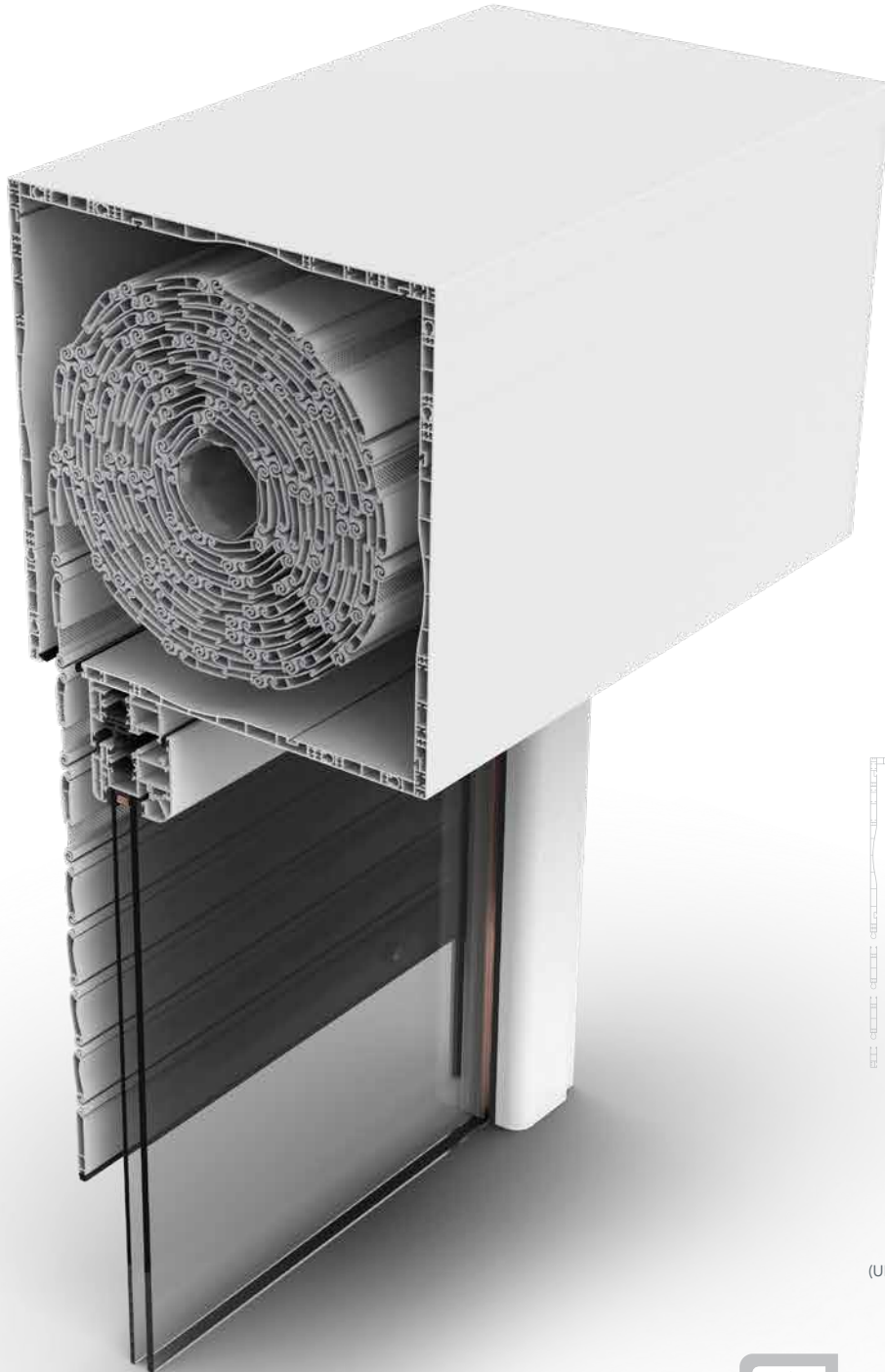

2,0 W/m²K
 Transmisión térmica U
 Thermal transmission
 (UNE-EN ISO 10077-2:2017)



R_w (C;Ctr)=35 (-2;-6)dB
 Acústico Noise
 (UNE-EN ISO 10140-2:2011)



CLASE class 4
 Permeabilidad al aire
 Air permeability
 (UNE-EN 1026:2017 /
 12207:2017)



CLASE class E3000
 Estanqueidad al agua
 Water resistance
 (UNE-EN 1027:2017 /
 12208:2000)



P3: 3000 Pa
 Resistencia al viento
 Wind load resistance
 (UNE-EN 12211:2017 /
 12210:2017)



PERFIL INFERIOR REGISTRABLE PARA CAJÓN TÚNEL

LOWER ACCESSIBLE PROFILE FOR TUNNEL-TYPE BOX



GRANDES ANCHOS.

Fabricado en PVC expandido consigue elevada rigidez por su espesor y su geometría con cámaras alveoladas.

LARGE DIMENSIONS. Made of expanded PVC, this system achieves high rigidity due to its thickness and its geometry with honeycomb chambers.

PERFECTA INTEGRACIÓN EN LA VENTANA, con la posibilidad de revestir en aluminio lacado.

COMPLETE INTEGRATION INTO THE WINDOW, with the possibility of coating in lacquered aluminium.

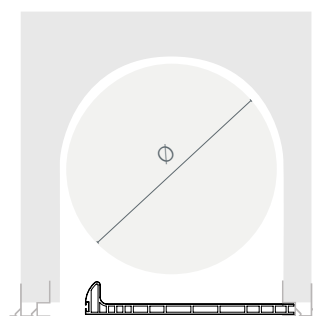

260 Ø 185 mm

280 Ø 205 mm

300 Ø 220 mm



260

280

300

CAJÓN PVC PVC SHUTTER BOX



REGILUX	REGILUX con mosquitera integrada PVC BOX WITH INTEGRATED ROLLER SYSTEM MOSQUITO NET	REGILINE
---------	---	----------

Ø	Ø	Ø
---	---	---

Tamaños Sizes	170	159 mm	-	-
	200	189 mm	154 mm	188 mm
Transmisión térmica U Thermal transmission	170 / 1,4 W/m ² K 200 / 1,0 W/m ² K		200 / 1,0 W/m ² K	
Acústico Noise	170 / Rw (C;Ctr)= 31 (-3; -7) dB 200 / Rw (C;Ctr)= 33 (-1; -5) dB		200 / Rw (C;Ctr)= 45 (-2; -6) dB	
Permeabilidad al aire Air permeability	170 / Clase Class 4 200 / Clase Class 3		200 / Clase Class 4	
Estanquidad al agua Water resistance	170 / Clase Class 9A 200 / Clase Class 7A		200 / Clase Class E3000	
Resistencia al viento Wind load resistance	P3: 3000 Pa		P3: 3000 Pa	

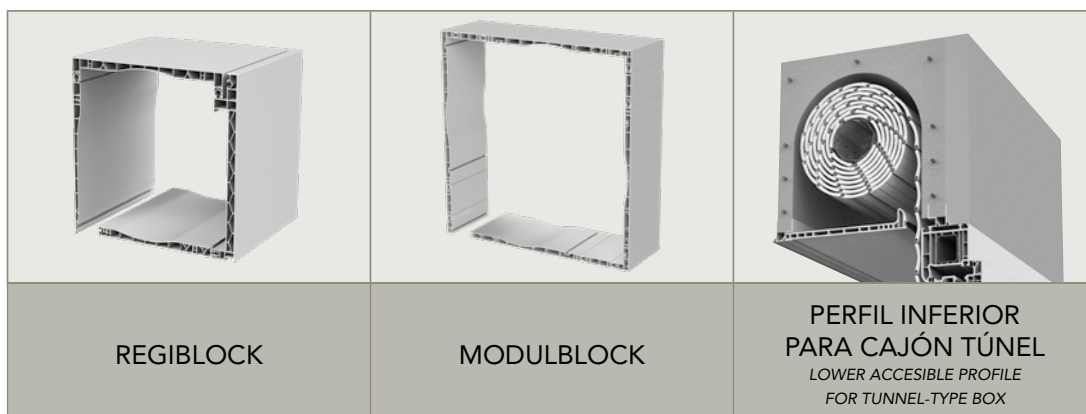

		REGIBLOCK	MODULBLOCK	PERFIL INFERIOR PARA CAJÓN TÚNEL <i>LOWER ACCESSIBLE PROFILE FOR TUNNEL-TYPE BOX</i>
		Ø	Ø	Ø
Tamaños Sizes	155	145 mm	-	-
	170	159 mm	-	-
	185	173 mm	-	-
	200	189 mm	-	-
	225	210 mm	-	-
	260	-	-	185 mm
	270	-	250 mm	-
	280	-	-	205 mm
	300	-	-	220 mm
	320	-	300 mm	-
	370	-	350 mm	-
Transmisión térmica U <i>Thermal transmission</i>		155 / 0,85 W/m²K 185 / 0,80 W/m²K 225 / 1,10 W/m²K	2,0 W/m²K	-
Acústico <i>Noise</i>		155 / Rw (C;Ctr)= 33 (-2; -5) dB 185 / Rw (C;Ctr)= 44 (-2; -6) dB 225 / Rw (C;Ctr)= 41 (-2; -7) dB	Rw (C;Ctr)= 35 (-2; -6) dB	-
Permeabilidad al aire <i>Air permeability</i>		155 / Clase <i>Class</i> 4 185 / Clase <i>Class</i> 4 225 / Clase <i>Class</i> 3	Clase <i>Class</i> 4	-
Estanquidad al agua <i>Water resistance</i>		155 / Clase <i>Class</i> 9A 185 / Clase <i>Class</i> E1200 225 / Clase <i>Class</i> E3000	Clase <i>Class</i> E3000	-
Resistencia al viento <i>Wind load resistance</i>		P3: 3000 Pa	P3: 3000 Pa	-

Nuestra cartera de productos es fruto de un trabajo constante de nuestro equipo profesional en la investigación, desarrollo y diseño y de una ardua investigación que durante años ha permitido posicionarnos entre los mejores fabricantes de cerramientos y sistemas de protección solar de PVC y aluminio.

Nuestra filosofía combina la elaboración de soluciones con prestaciones técnicas de alta calidad junto a la intensa dedicación en la satisfacción de clientes exigentes que buscan soluciones de confort para proteger su vivienda.

Somos fabricantes y cuidamos hasta el mínimo detalle para asegurar el más alto nivel de calidad en todos los productos que ofrecemos. Buscamos aquellos valores que nos definen como marca y sobre los que radica nuestra diferenciación: la **calidad**, el **diseño**, la **capacidad de respuesta** y el **servicio** forman el ADN de LaViuda.

Our product portfolio is the result of our professional team's constant work in research, development and design as well as of an arduous investigation that for years has allowed us to position ourselves among the best manufacturers of PVC and aluminium enclosures and solar protection solutions.

Our philosophy combines the development of solutions that have a high-quality technical performance together with an intense dedication to the satisfaction of demanding customers who seek comfort solutions to protect their home.

We are manufacturers and take care of even the smallest detail to ensure the highest level of quality in all the products we offer. We seek those values that define us as a brand and on which our differentiation lies: **quality**, **design**, **responsiveness** and **customer service** form LaViuda's DNA.

